

punt

ART, CRAFT & DESIGN



STOCKHOLM

TECHNICAL INFORMATION SHEET

STOCKHOLM

BY MARIO RUIZ, 2013

punt



PRODUCT TYPE

Bedside tables, sideboards, chest drawers & cupboards

The large Stockholm family, consisting of sideboards, cupboards, chests of drawers, bedside tables, tables, coffee tables, desks, lamps and rugs, is characterized by the unique use of aluminum as the material that connects all the pieces. The collection won the Red Dot Award in 2015 and has become a Punt signature icon.

TIPOLOGÍA DE PRODUCTO

Mesitas de noche, aparadores, cómodas y alacenas

La gran familia Stockholm, compuesta por aparadores, alacenas, cómodas, mesitas de noches, mesa, mesas bajas, escritorios, lámparas y alfombras, se caracteriza por el singular uso del aluminio como hilo conductor entre todas las piezas. La colección fue merecedora del premio Red Dot en 2015 y se ha convertido en un icono de la firma Punt.

DETAILS. DETALLES



STOCKHOLM

BY MARIO RUIZ, 2013

punt

DIMENSIONS BEDSIDE TABLES. DIMENSIONES MESITAS DE NOCHE

STH151 Slim

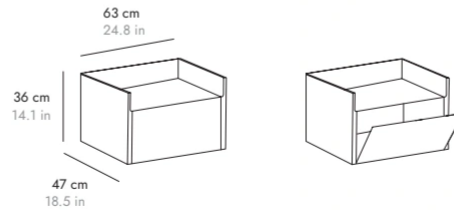

STH153 Slim + Technic doors

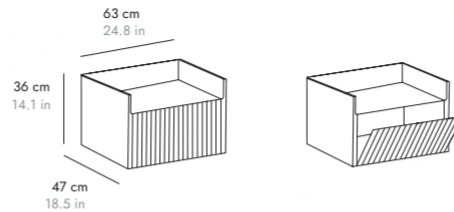

STH105

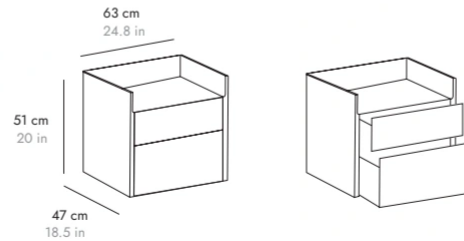

1 UNIT METAL BASE. ZÓCALOS 1 MÓDULO

ZOC011

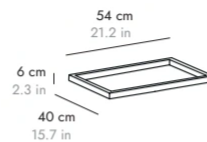

ZOC117

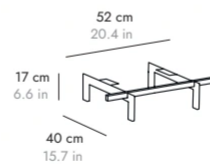

STOCKHOLM

BY MARIO RUIZ, 2013

punt

DIMENSIONS 2 UNITS SIDEBBOARD. DIMENSIONES APARADORES 2 MÓDULOS

STH251 Slim

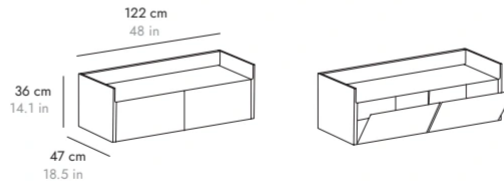

STH253 Slim + Technic doors

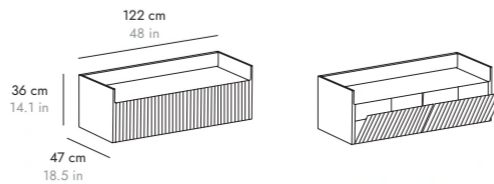

STH201

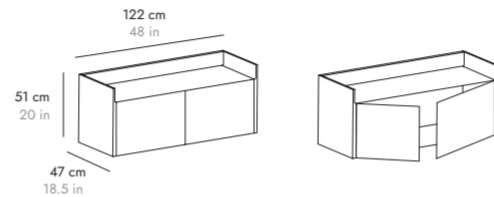

STH203 Technic doors

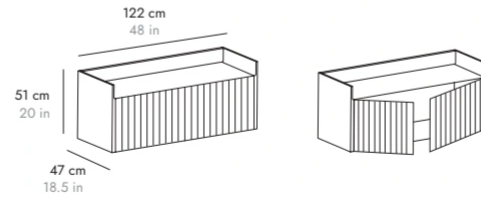

2 UNITS METAL BASE. ZÓCALOS 2 MÓDULOS

ZOC021

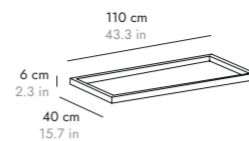

ZOC217

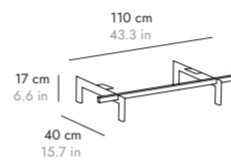

ZOC229

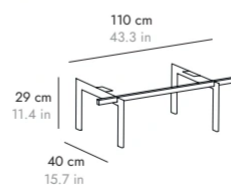

STOCKHOLM

BY MARIO RUIZ, 2013

punt

DIMENSIONES 3 UNITS SIDEBOARD. DIMENSIONES APARADORES 3 MÓDULOS

STH351 Slim

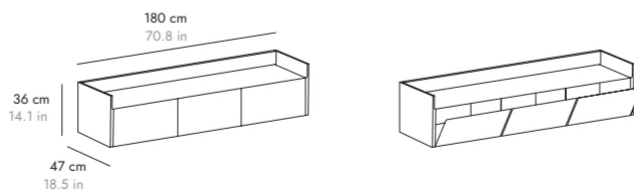

STH353 Slim + Technic door

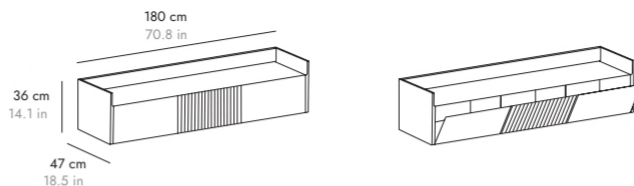

STH354 Slim + Technic doors

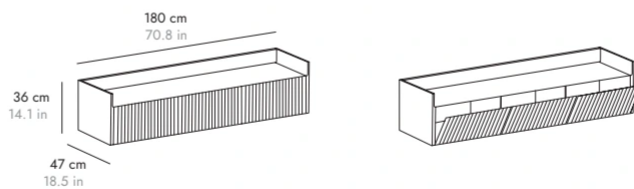

STH301

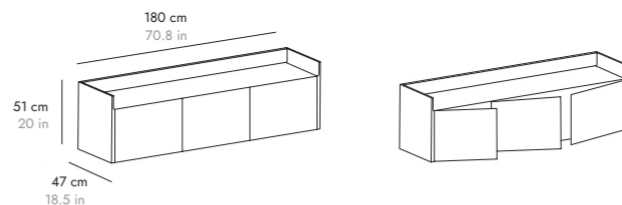

STH302

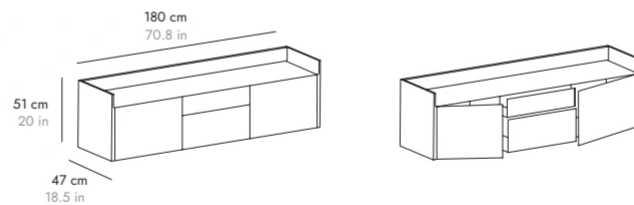

STOCKHOLM

BY MARIO RUIZ, 2013

punt

STH303 Technic door

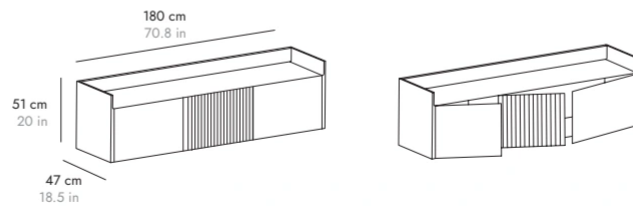

STH304 Technic doors

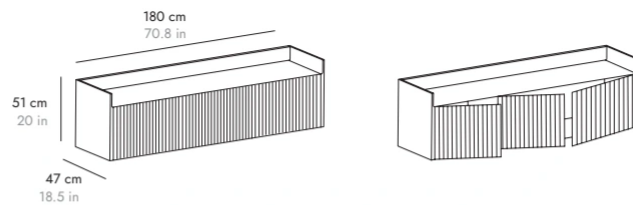

3 UNITS METAL BASE. ZÓCALOS 3 MÓDULOS

STH031

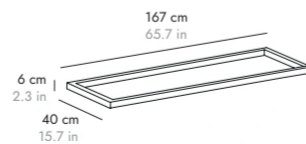

STH317

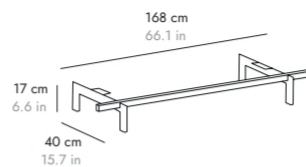

STH329

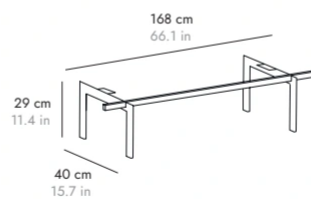

STOCKHOLM

BY MARIO RUIZ, 2013

punt

DIMENSIONS 4 UNITS SIDEBBOARD. DIMENSIONES APARADORES 4 MÓDULOS

STH451 Slim

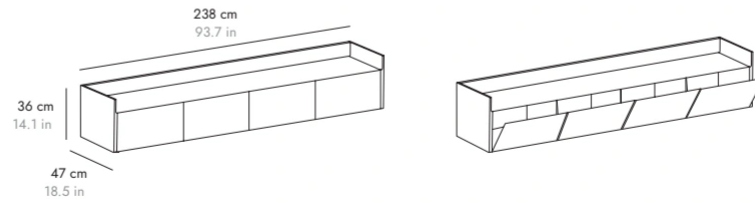

STH453 Slim + Technic door

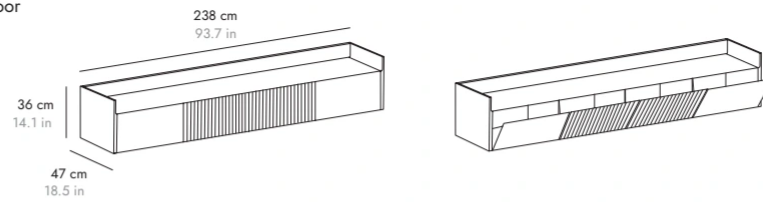

STH454 Slim + Technic doors

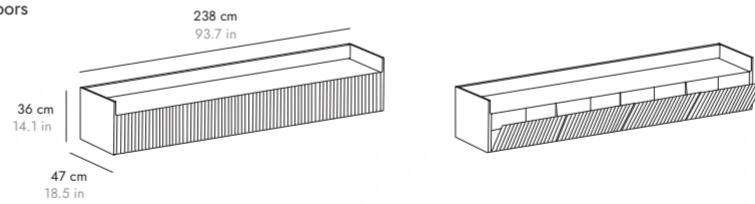

STH401

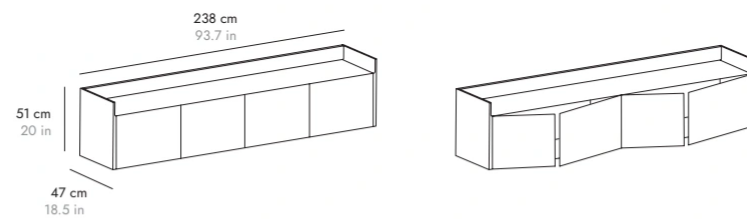

STH402

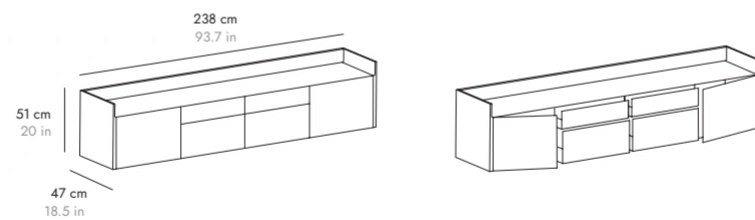

STOCKHOLM

BY MARIO RUIZ, 2013

punt

STH403 Technic doors

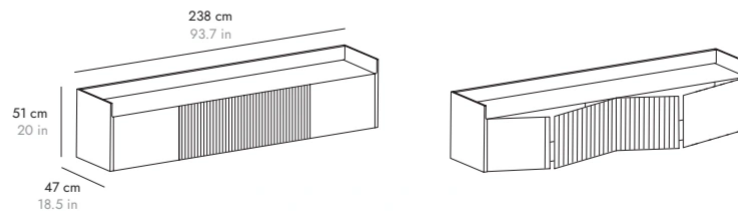

STH404 Technic doors

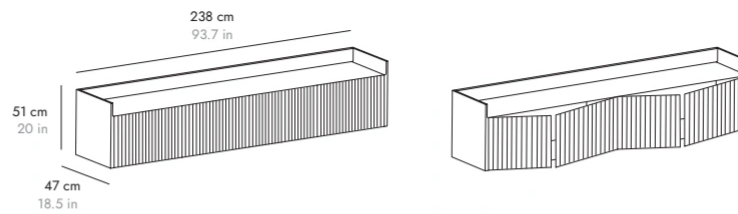

4 UNITS METAL BASE. ZÓCALOS 4 MÓDULOS

STH041

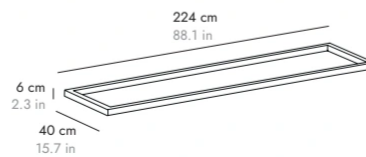

STH417

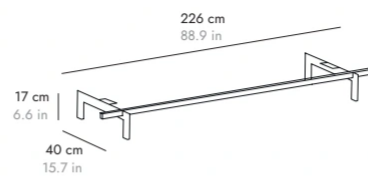

STH429

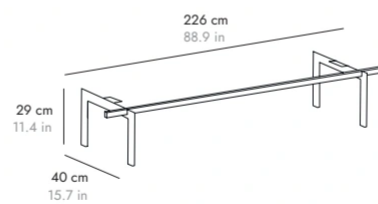

STOCKHOLM

BY MARIO RUIZ, 2013

punt

DIMENSIONS 5 UNITS SIDEBBOARD. DIMENSIONES APARADOR 5 MÓDULOS

STH553 Slim

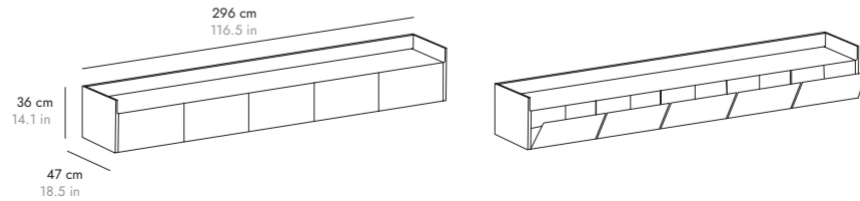

STH556 Slim + Technic doors

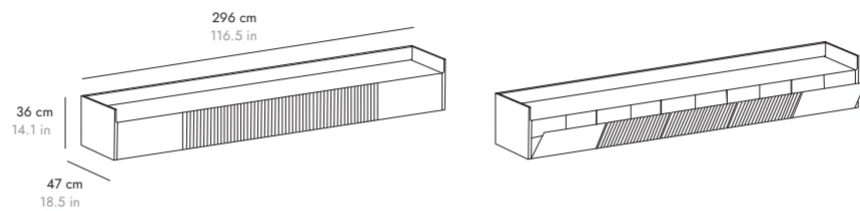

STH557 Slim + Technic doors

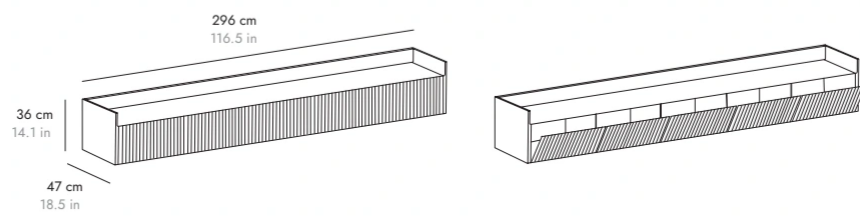

STH503

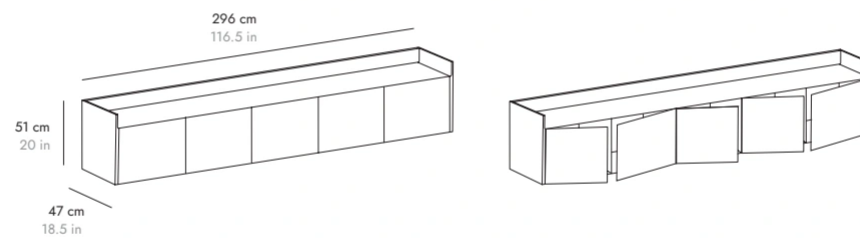

STOCKHOLM

BY MARIO RUIZ, 2013

punt

STH504 Slim + Technic doors

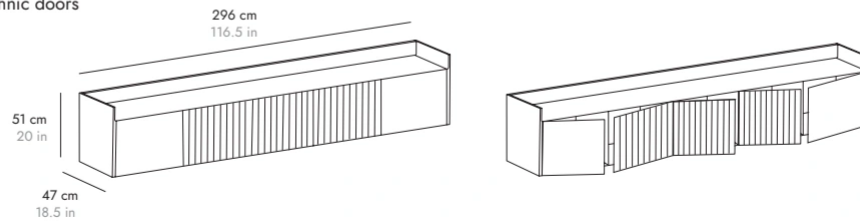

STH507 Slim + Technic doors

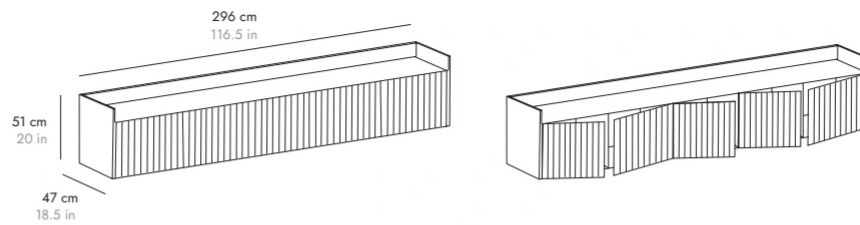

5 UNITS METAL BASE. ZÓCALOS 5 MÓDULOS

STH051

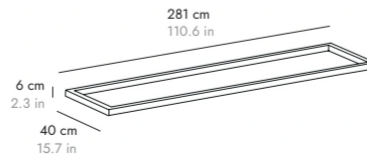

STH517

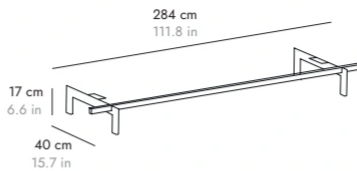

STH529

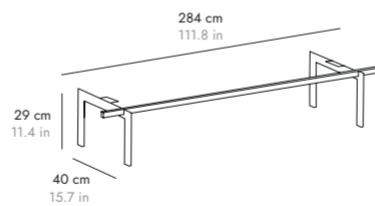

STOCKHOLM

BY MARIO RUIZ, 2013

punt

DIMENSIONS CUPBOARDS. DIMENSIONES ALACENAS

STH011

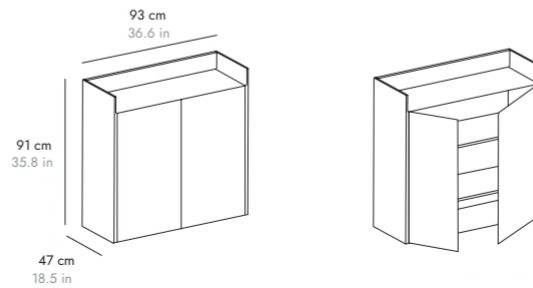

STH111

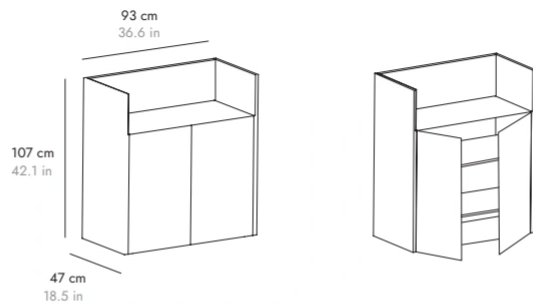

CUPBOARDS METAL BASE. ZÓCALOS ALACENAS

ZOC010

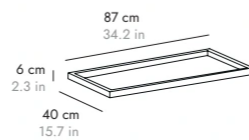

ZOC817

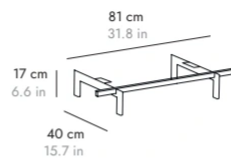

ZOC829

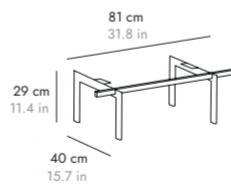

STOCKHOLM

BY MARIO RUIZ, 2013

punt

DIMENSIONS CUPBOARDS. DIMENSIONES ALACENAS

STH224 2 units metal base.
Zócalo 2 módulos.

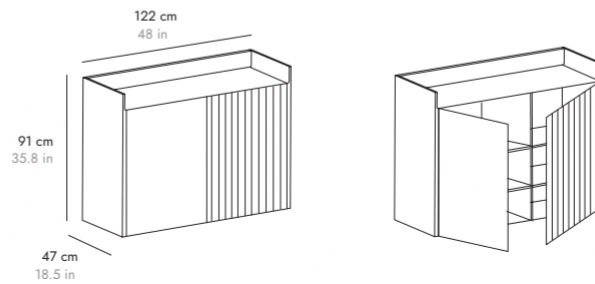

STH221 2 units metal base.
Zócalo 2 módulos.

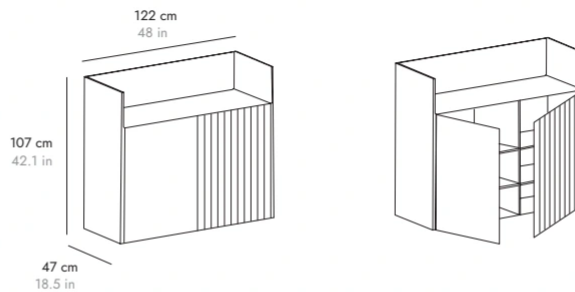

STH334 3 units metal base.
Zócalo 3 módulos.

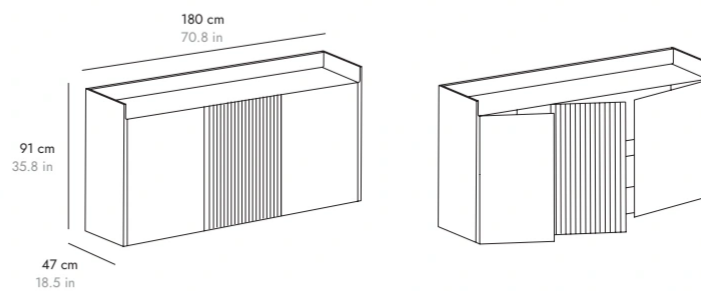

STH434 4 units metal base.
Zócalo 4 módulos.

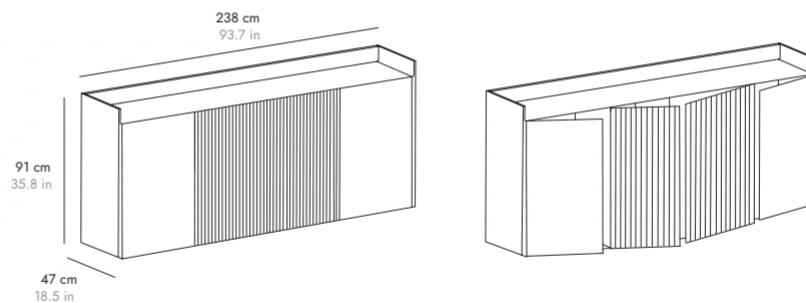

STOCKHOLM

BY MARIO RUIZ, 2013

punt

DIMENSIONS CHEST OF DRAWERS. DIMENSIONES CÓMODAS

STH012

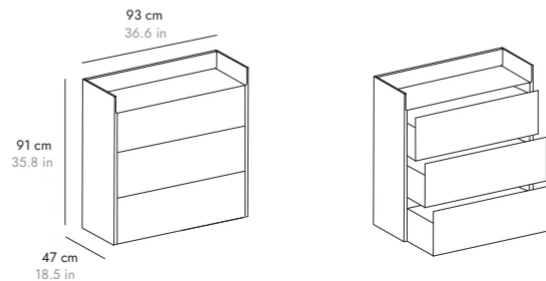

STH112

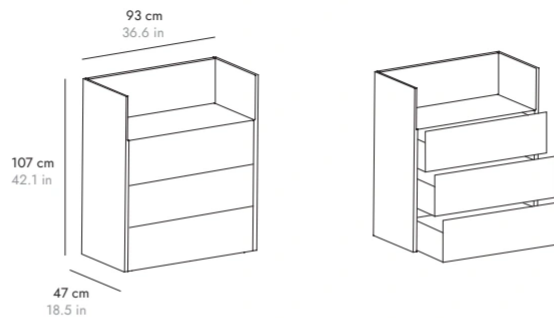

CHEST DRAWERS METAL BASE. ZÓCALOS CÓMODAS

ZOC010

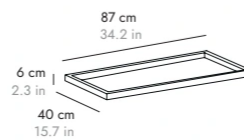

ZOC817

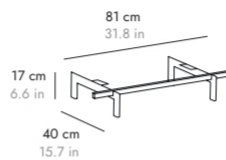

ZOC829

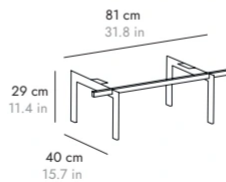

STOCKHOLM

BY MARIO RUIZ, 2013

punt

DIMENSIONS DESKS. DIMENSIONES ESCRITORIOS

STH502

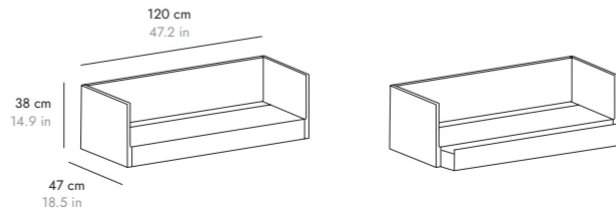

STH512

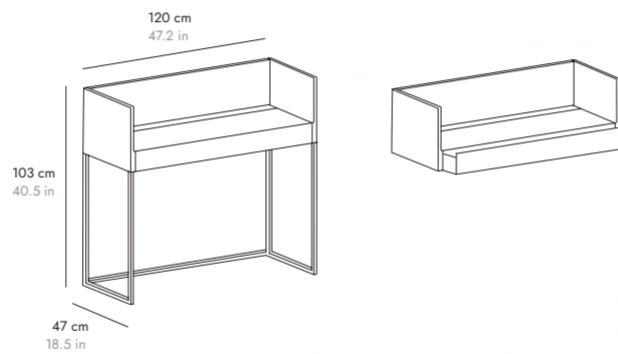

ACCESSORIES STOCKHOLM COLLECTION. ACCESORIOS COLECCIÓN STOCKHOLM

ACC027

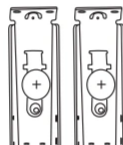

Fittings for hanging the modules on the wall.
Please consult the number of units required for each composition.

Herrajes para fijar los módulos a pared.
Consultar número de unidades necesarias para cada composición.

STOCKHOLM

BY MARIO RUIZ, 2013

punt

TECHNICAL SPECIFICATIONS. ESPECIFICACIONES TÉCNICAS

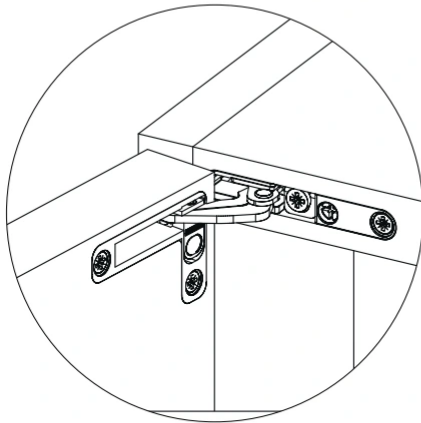

Invisible hinge fitting for side opening.
Herraje de bisagra invisible para apertura lateral.

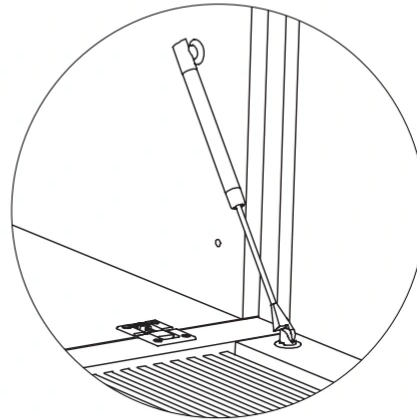

Downward opening system for SLIM sideboards.
Sistema de apertura descendente para aparadores SLIM.

-
- Handleless doors with 105° opening.
 - Puertas sin tiradores con apertura a 105°.

- Drawers with full-extension runners.
- Cajones con guías de extracción total.

- Units with doors include height adjustable shelf.
- Los módulos con puertas incluyen estante regulable en altura.

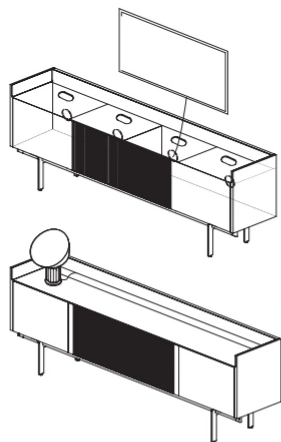

The Stockholm collection offers the possibility to order cable grommets. In this case, there will always be one grommet per door. Consult conditions with the sales department.

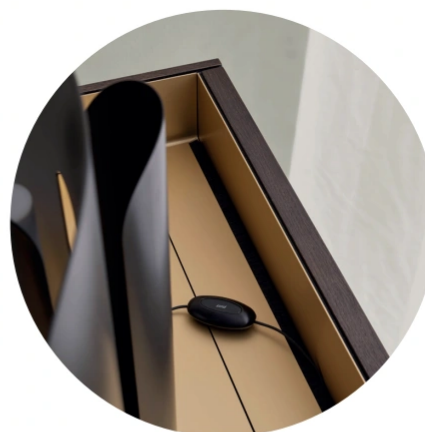

La colección Stockholm ofrece la posibilidad de solicitar pasacables. En ese caso, siempre se realizará un pasacables por puerta. Consultar condiciones con el departamento comercial.

STOCKHOLM

BY MARIO RUIZ, 2013

punt

MATERIALS

Wood.

Interior and exterior modules in E1 MDF board and E1 particle board (low formaldehyde content) clad in oak or natural walnut with continuous mesh. Technic finish doors are solid wood slatted doors.

Aluminum.

Top in anodized aluminum or smooth matte metal.

Steel.

Textured thermo-lacquered steel plinths with adjustable feet.

MATERIALES

Madera.

Módulos interior y exterior en tablero de MDF E1 y tablero de partículas E1 (bajo contenido en formaldehído) aplacado en madera de roble o nogal natural con malla continua. Las puertas en acabado Technic son alistonadas en madera maciza.

Aluminio.

Tapa de aluminio anodizado o metal liso mate.

Acero.

Zócalos de acero termo-lacado texturizado con pies regulables.

Units & doors. Módulos y puertas

A



SUPER MATT OAK
ROBLE SÚPER MATE
CHENE SUPERMATE
SUPER MATT EICHE
ROVERE OPACO

C



WHITENED OAK
ROBLE BLANQUEADO
CHENE BLANCHI
EICHE WEISS
ROVERE SBIANCATO

C



WALNUT STAINED OAK
ROBLE TEÑIDO NOGAL
CHENE TEINTÉ NOYER
EICHE NUSSBAUM
GEBEIZT
ROVERE TINTO NOLE

C



DARK GREY STAINED OAK
ROBLE TEÑIDO GRIS
CHENE TEINTE GRIS
DUNKELGRAU GEBEIZTE
EICHE
ROVERE TINTO GRIGIO
SCURO

C

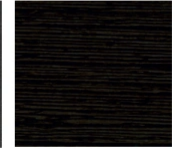

EBONY STAINED OAK
ROBLE TEÑIDO ÉBANO
CHENE TEINTÉ ÉBÔNE
EICHE GEBEIZT
EBENHOLZ
ROVERE TINTO ÈBANO

B



SUPER MATT WALNUT
NOGAL SÚPER MATE
NOYER SUPER MATE
SUPERMATT WALNUSS
NOCE OPACO

D



WALNUT STAINED WALNUT
NOGAL TEÑIDO NOGAL
NOYER TEINTÉ NOYER
WALNUSS GEBEIZT
WALNUSS
NOCE TINTO NOCE

D



DARK STAINED WALNUT
NOGAL TEÑIDO OSCURO
NOYER TEINTÉ FONCÉ
WALNUSS DUNKEL
GEBEIZT
NOCE TINTO SCURO

Top. Tapa



GOLD
ORO
DORÉ
GOLD
ORO

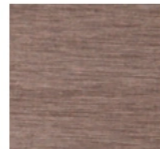

PALE ROSE
ROSA PÁLIDO
PALE ROSE
PALE ROSE
PALE ROSE



BRONZE
BRONCE
BRONZE
BRONZE
BRONZE

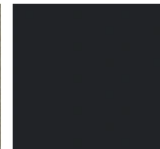

BLACK
NEGRO
NOIR
SCHWARZ
NERO

Metal base. Zócalo

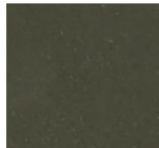

BRONZE
BRONCE
BRONZE
BRONZE
BRONZE
BRONZE



BLACK
NEGRO
NOIR
SCHWARZ
NERO